

Letter	Zone	Description	Date	By	Approved
A		PRE-PRODUCTION RELEASE	3-99	A. R	G. A. D
B		UPDATED PER ECO#2495	5-99	A. R	

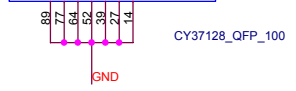
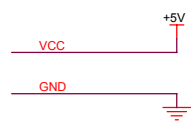
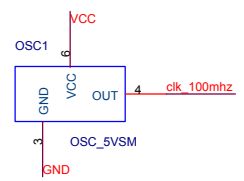
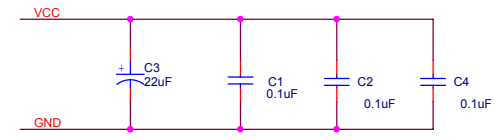
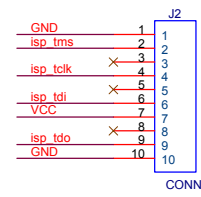
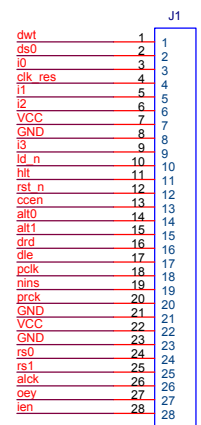
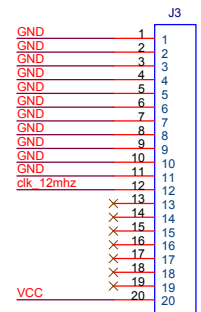
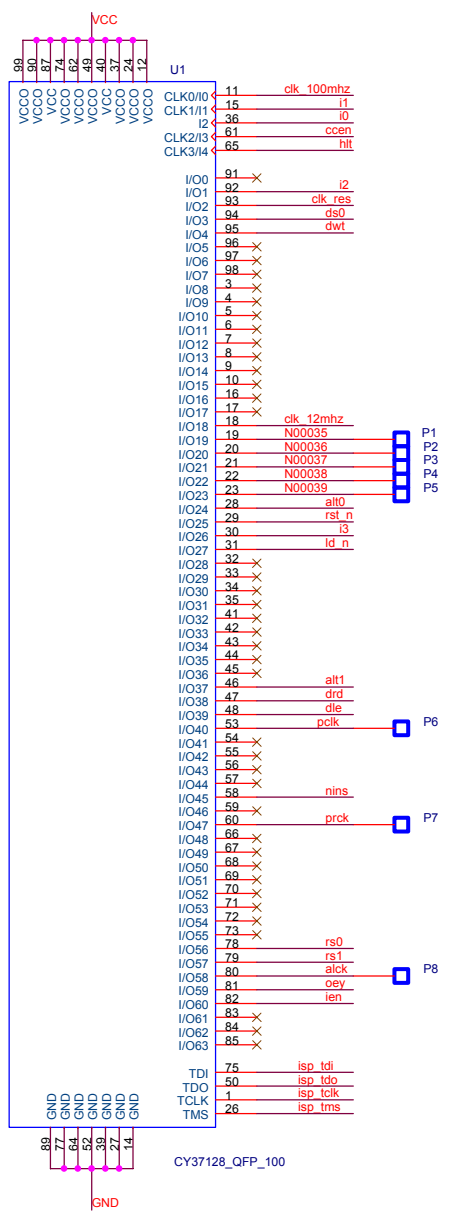

This drawing and specification herein are the property of Peripherals Corporation and shall not be reproduced or copied or used in whole or in part as the basis for the manufacture or sale of items without written permission.

Full Schematic

Peripherals Corp.
4000 Veterans Memorial Highway
Bohemia, NY 11716

APPROVED:

Title: VPCE-1000

Size B	Document Number 5136467	Rev B
Date: Wednesday, May 05, 1999	Sheet 1 of 1	
Document File Name: C:\ASHTON\DESIGNS\VPCE1000\DRAW\REV_B\VPCE1000.DSN		